

Panel Frame Overview Instructions

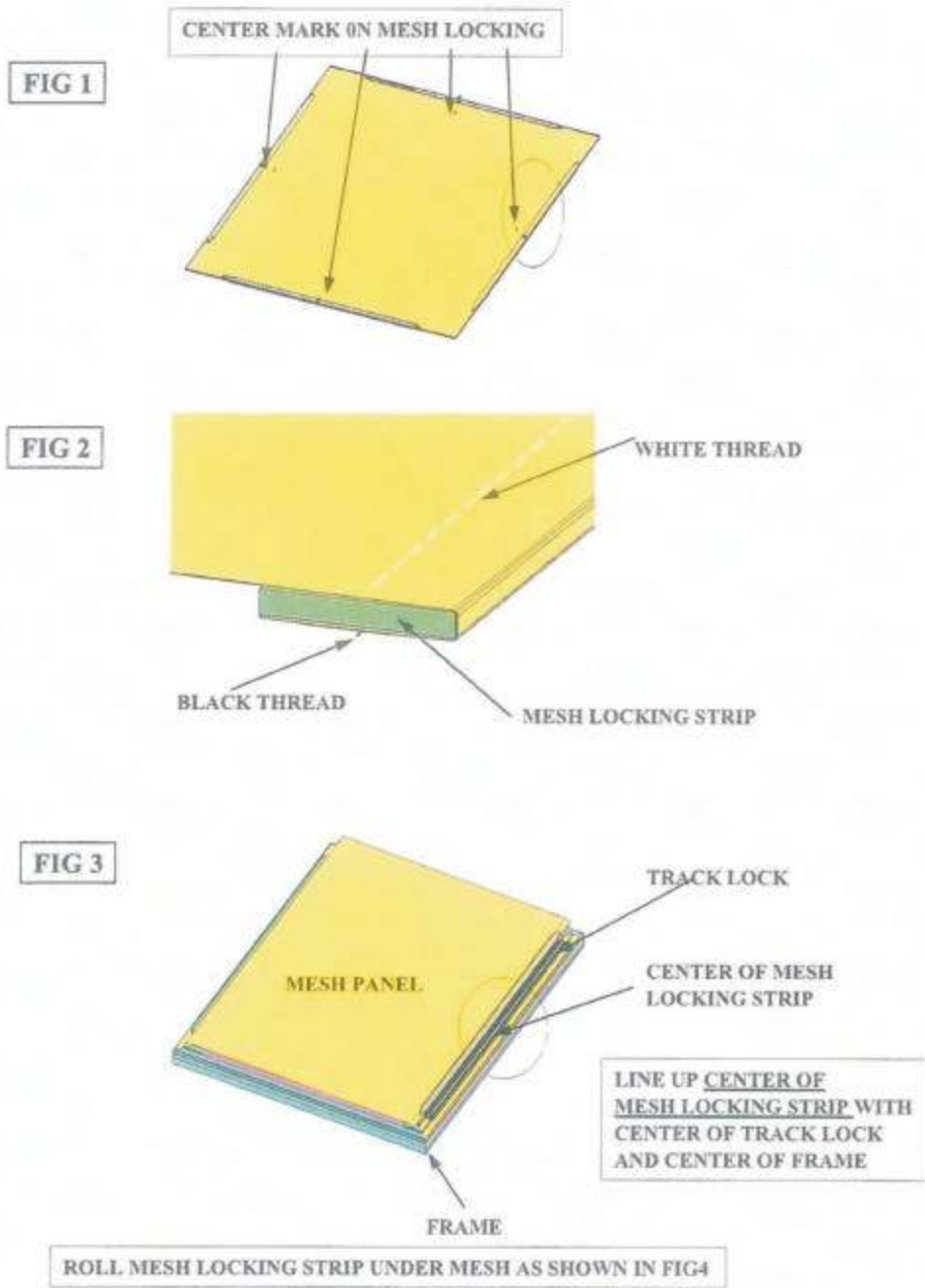

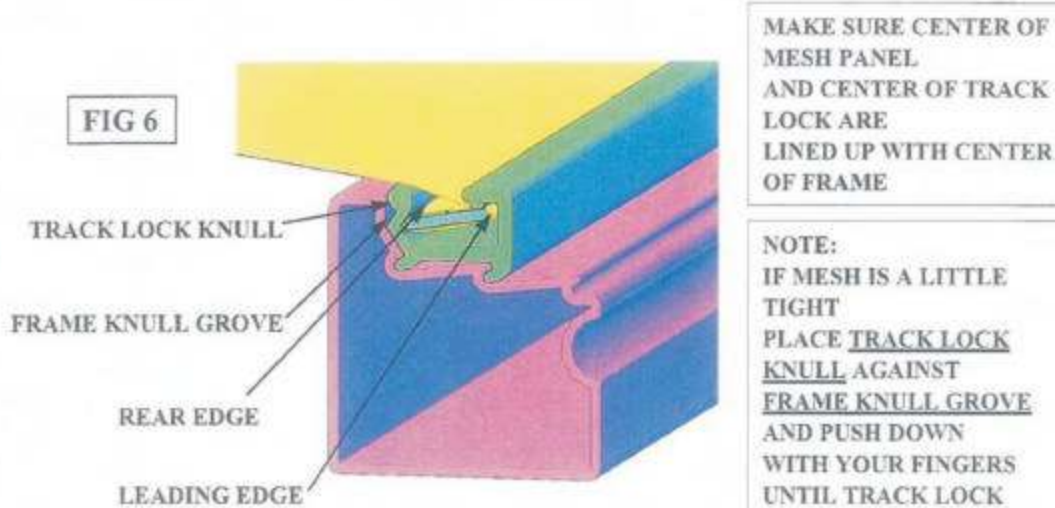
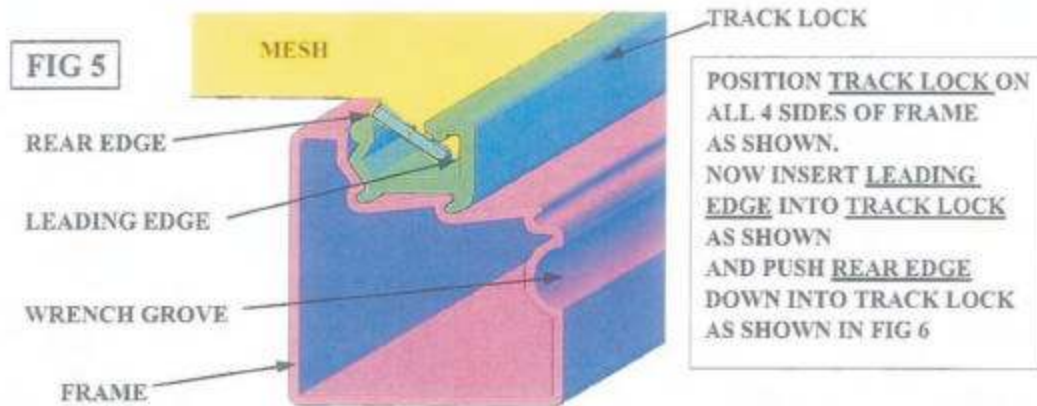
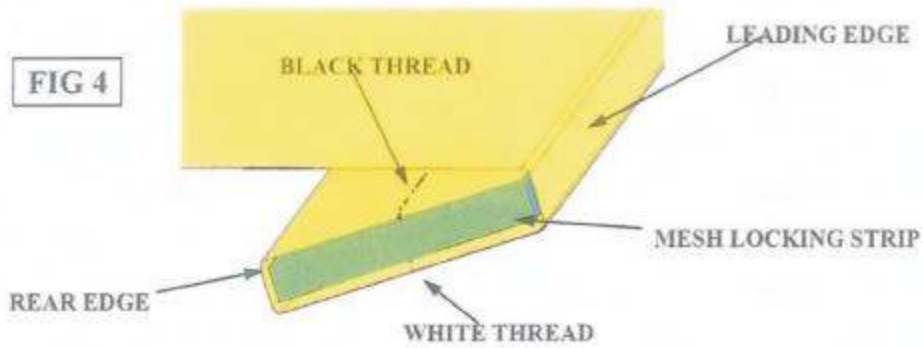

REPEAT FIG 5 AND FIG 6 ON ALL 4 SIDES OF FRAME

NOTE:
IF MESH IS A LITTLE TIGHT
PLACE TRACK LOCK KNULL AGAINST FRAME KNULL GROOVE AND PUSH DOWN WITH YOUR FINGERS UNTIL TRACK LOCK ENGAGES FRAME AS SHOWN IN FIG 6

FIG 7

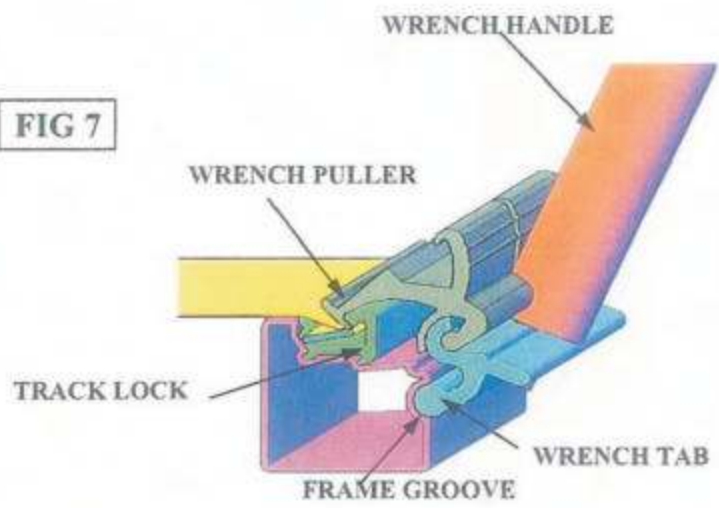

ENGAGE WRENCH PULLER WITH TRACK LOCK AS SHOWN. SEAT WRENCH TAB IN FRAME GROOVE. NOW SLOWLY PULL DOWN ON WRENCH HANDLE UNTIL TRACK LOCK SEATS IN POSITION SHOWN IN FIG 8

FIG 8

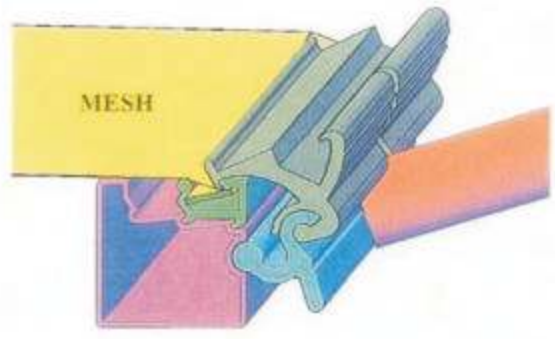

NOW REPEAT FIG 7 AND FIG 8 ON ALL 4 SIDES.

FIG 9

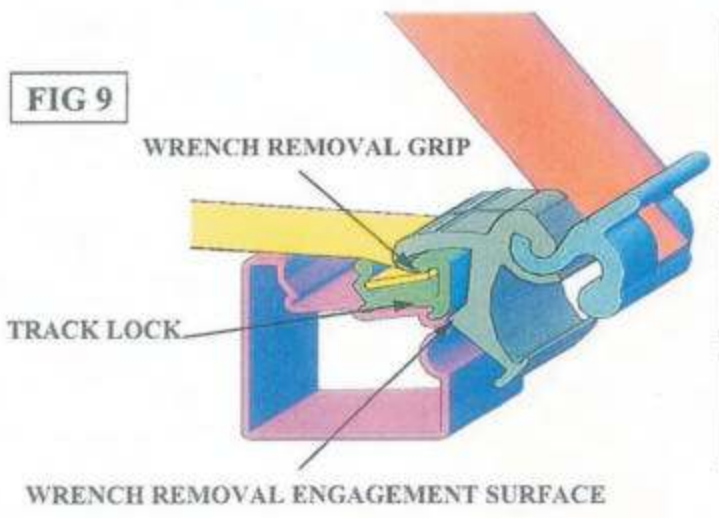

TO REMOVE MESH ENGAGE WRENCH REMOVAL GRIP WITH TRACK LOCK AS SHOWN

MAKE SURE WRENCH REMOVAL ENGAGEMENT SURFACE IS AS SHOWN.

PULL HANDLE BACK TO REMOVE TRACK LOCK AND REMOVE MESH.



ST. LOUIS HEADQUARTERS
5110 Penrose Street • St. Louis, MO 63115
314-382-9300 • 800-325-8317 • FAX 314-382-3012
E-mail: info@lawsonsp.com • www.lawsonsp.com